

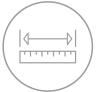

customised prints



antibacterial treatment



special measures



lighting available



removable



bicolor

DOT

Single-sided sound-absorbing panel upholstered in fabric, which can be installed on the wall or on the ceiling with special tracks. It can be hung from the ceiling by adjustable cables.

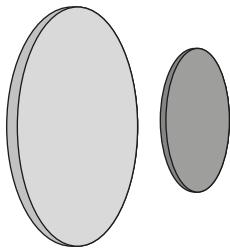

Walls: hooked on tracks

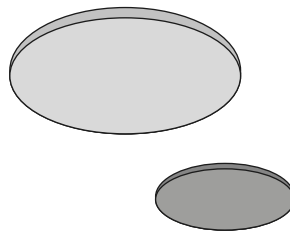

Ceiling: hooked on tracks

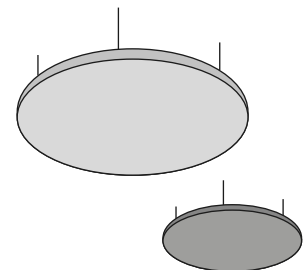

Ceiling: vertical cables, isolated position

COMPOSITION

Metal Framework

Inner frame in galvanised sheet metal 0,8 mm thick.

Sound-absorbing material

Inner sound-absorbing padding 50 mm thick realised in Basotect® melamine resin by Basf® (8,5-11,5 Kg/m3) or in Stratocell® Whisper® (25 kg/m3).

Fabric

Oeko-Tex certified removable and recyclable fabric covering, 100% Polyester FR - (Tr Cs). Colours as in colour chart. High-resolution and custom fabric print with non-toxic and water-based inks resistant to washing, which do not alter the fabric sound-absorbing properties and elasticity.

WEIGHTS AND DIMENSIONS

ME = Melamina Basotect® by Basf® SW = Stratocell® Whisper®

Material	Dimension	Weight
ME / SW	Ø 120 x 5 cm	7 kg

All the weights shown in this table are purely indicative.

Ø 120 cm

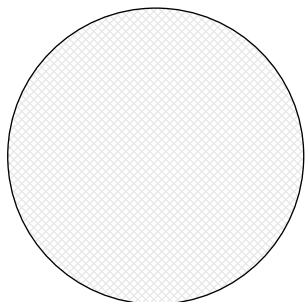

Special measures on request/ project basis

CERTIFICATIONS

1. Sound absorption test in compliance with UNI EN ISO 354
2. Formaldehyde test Ansi-Bifma M7.1
3. Fire resistance tests

- UNI EN 13501-01 ClassB-s2, d0 - for the whole panel made of Basotect® melamine resin foam by Basf® and for the whole panel made of Stratocell® Whisper®
- American requirements USA ASTM E84-15b - for the whole panel made of Basotect® melamine resin by Basf®

MAINTENANCE

Use the vacuum-cleaner with smooth spout regularly, don't brush

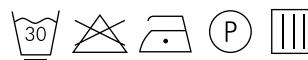

FIXING SYSTEMS AND ACCESSORIES

ADHERENCE PANEL

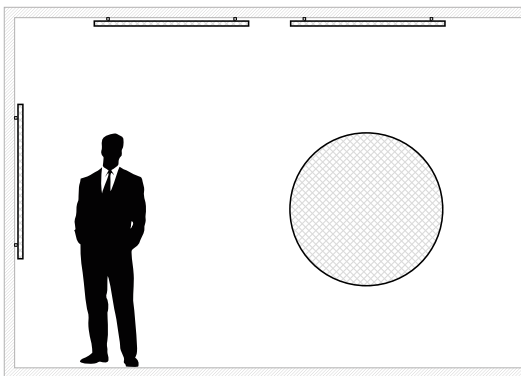

A - Wall or ceiling installation kit with 2 customised bars

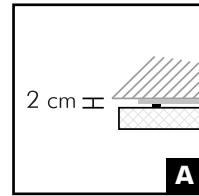
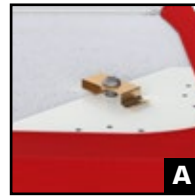
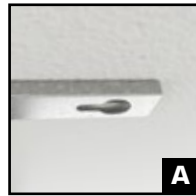

HANGING PANEL

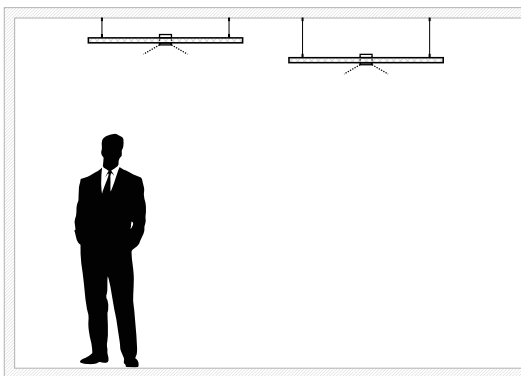

A - Suspension kit
(3 small 150cm cables, 3 adjustable safety hooks)

A - Suspension kit
(3 small 400cm cables, 3 adjustable safety hooks)

B - Ceiling Suspension kit
(3 small 200cm cables, 3 safety hooks, 3 cable ties with screw hole Ø M6)

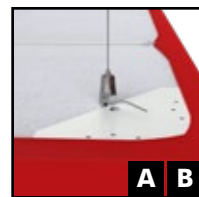
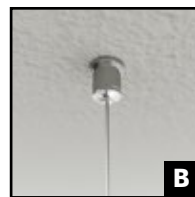
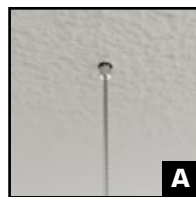

SUSPENDED CEILING

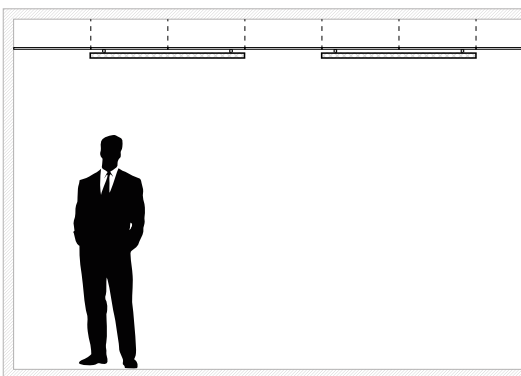

A - Installation kit on T-element for suspended ceiling

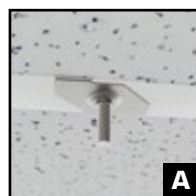

DOT WITH 1 DIFFUSED LED SPOTLIGHT

Available for panels with suspended application. 



TECHNICAL SPECIFICATIONS

Dimensions round: Ø130mm (13W) | Ø180mm (23W) | Ø210mm (30W)
 Power: from 13W to 30W
 Light colour: 4000°K, 3000°K
 Lumen: from 1488lm to 3672lm
 Driver: on/off or dimmer
 Certifications: CE

For lighting technical data sheets, please contact the sales department.

ME = Melamina Basotect® by Basf® SW = Stratocell® Whisper®

Material	Dimension	Weight	Power
ME / SW	Ø 120 x 5 cm	7 kg	13 W
ME / SW	Ø 120 x 5 cm	7 kg	23W
ME / SW	Ø 120 x 5 cm	7 kg	30 W

LIGHT POSITIONING

Ø 120 cm

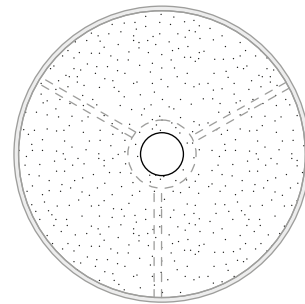

Price referred to the panel with integrated lighting system (excluding accessories, fixing systems and any customisations).

Stratocell® Whisper® sound absorbing material available on request, quotation on project.

All the weights shown in this table are purely indicative.

DOT WITH 1 LED SPOTLIGHT

Available for panels with suspended application. 



TECHNICAL SPECIFICATIONS

Optical fixed: 40°
 Power: 13W
 Visible frame color: White RAL 9003 embossed - Grey RAL 9006 embossed - Black RAL 9005 embossed
 Dimensions round Ø76 mm
 Light colour: 4000°K, 3000°K
 Driver: on/off or dimmer
 Certifications: CE

For lighting technical data sheets, please contact the sales department.

ME = Melamina Basotect® by Basf® SW = Stratocell® Whisper®

Material	Dimension	Weight	Power
ME / SW	Ø 120 x 5 cm	7 kg	13 W

LIGHT POSITIONING

Ø 120 cm

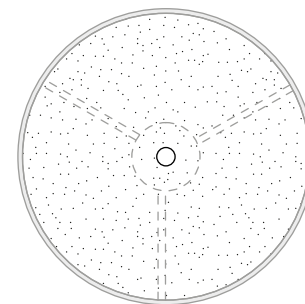

Price referred to the panel with integrated lighting system (excluding accessories, fixing systems and any customisations).

Stratocell® Whisper® sound absorbing material available on request, quotation on project.

All the weights shown in this table are purely indicative.

For panels with integrated lighting systems fabric cover removable with the intervention of authorised Caruso Acoustic personnel.

DOT WITH REAR LED LINE



TECHNICAL SPECIFICATIONS

Potenza: 19,2 W/m - 240 LEDs/m
Light colour: 5000°K, 4000°K, 2700°K
Driver: on/off or dimmer
Certifications: CE