

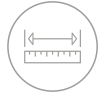

customised
prints



antibacterial
treatment



special
measures



removable

SCRIBA

Double-sided sound-absorbing panel upholstered in fabric. Installation on desk with clamps, put on special bases or on existing groove.

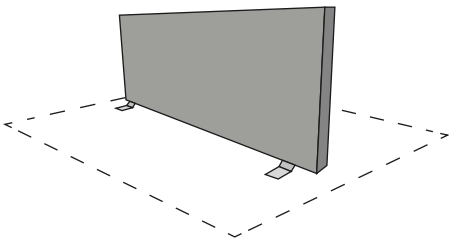

Desk: with support or fixed to the desk

COMPOSITION

Metal Framework

Inner frame in galvanised sheet metal 0,8 mm thick.

Sound-absorbing material

Inner sound-absorbing padding 50 mm thick realised in Basotect® melamine resin by Basf® (8,5-11,5 Kg/m³) or in Stratocell® Whisper® (25 kg/m³).

Fabric

Oeko-Tex certified removable and recyclable fabric covering, 100% Polyester FR - (Tr Cs). Colours as in colour chart. High-resolution and custom fabric print with non-toxic and water-based inks resistant to washing, which do not alter the fabric sound-absorbing properties and elasticity.

WEIGHTS AND DIMENSIONS

ME = Melamina Basotect® by Basf® SW = Stratocell® Whisper®

Material	Dimension	Weight
ME / SW	120 x 40 x 5 cm	2 kg
ME / SW	140 x 40 x 5 cm	3 kg
ME / SW	160 x 40 x 5 cm	3 kg
ME / SW	180 x 40 x 5 cm	4 kg

Material	Dimension	Weight
ME / SW	120 x 50 x 5 cm	3 kg
ME / SW	140 x 50 x 5 cm	4 kg
ME / SW	160 x 50 x 5 cm	4 kg
ME / SW	180 x 50 x 5 cm	4 kg

All weights in this table are purely indicative and refer to single panels (accessories excluded).

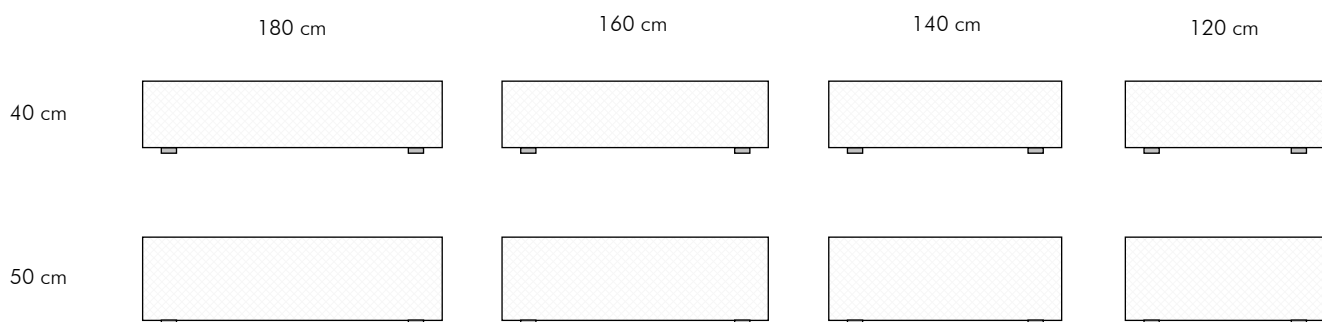

Special measures on request/ project basis

CERTIFICATIONS

1. Sound absorption test in compliance with UNI EN ISO 354
2. Formaldehyde test Ansi-Bifma M7.1
3. Fire resistance tests

- UNI EN 13501-01 ClassB-s2, d0 - for the whole panel made of Basotect® melamine resin foam by Basf® and for the whole panel made of Stratocell® Whisper®
- American requirements USA ASTM E84-15b - for the whole panel made of Basotect® melamine resin by Basf®

MAINTENANCE

Use the vacuum-cleaner with smooth spout regularly, don't brush

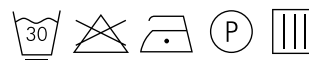

FIXING SYSTEMS AND ACCESSORIES

FEET

2 desk support bases painted in grey aluminium*

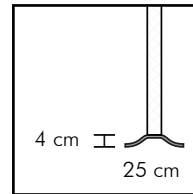
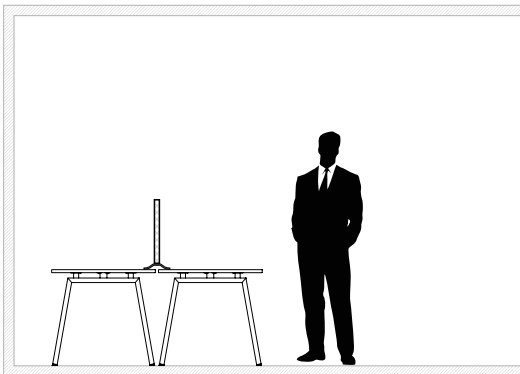

CLAMPS

A - Anchor kit for desk - 2 clamps

B - Anchor kit for desk - 2 clamps + 2 spacers

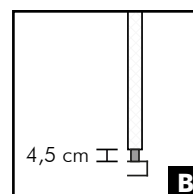
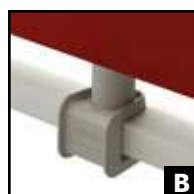
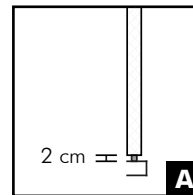
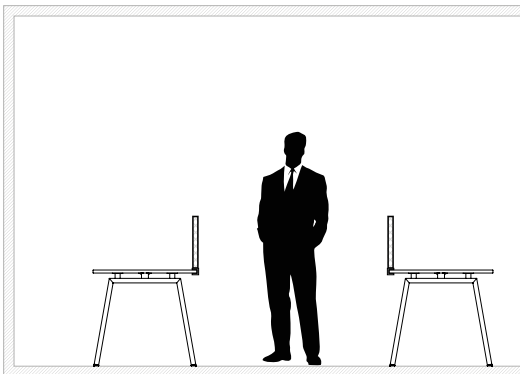

ON EXISTING TRACK

Anchor kit for desk - 2 spacers
(for fixing of the panels on existing track)

