

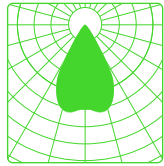

LTwo® – 60° – wide flood constant current @600mA – 25 Watt/m



Ø 16,4 mm



Gesamthöhe
total height
21,6 mm

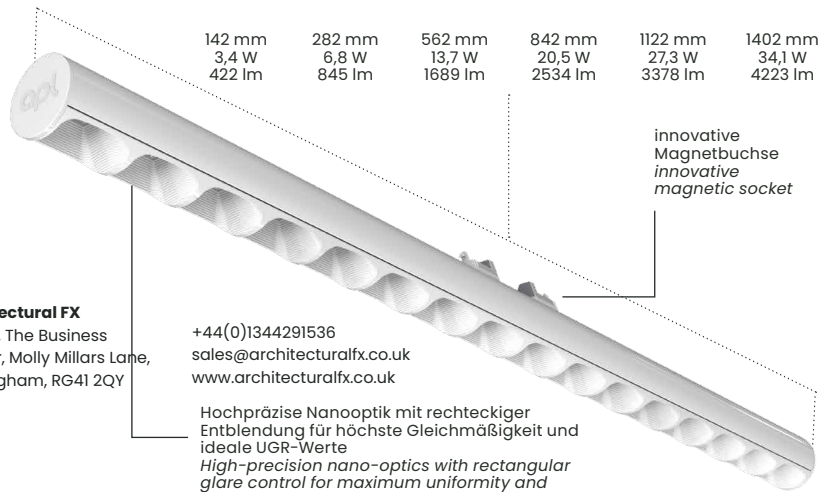

142 mm	282 mm	562 mm	842 mm	1122 mm	1402 mm
3,4 W	6,8 W	13,7 W	20,5 W	27,3 W	34,1 W
422 lm	845 lm	1689 lm	2534 lm	3378 lm	4223 lm

innovative
Magnetbuchse
innovative
magnetic socket

Architectural FX
Unit 16, The Business
Center, Molly Millars Lane,
Wokingham, RG41 2QY

+44(0)1344291536
sales@architecturalfx.co.uk
www.architecturalfx.co.uk

Hochpräzise Nanooptik mit rechteckiger
Entblendung für höchste Gleichmäßigkeit und
ideale UGR-Werte
High-precision nano-optics with rectangular
glare control for maximum uniformity and
ideal UGR values



reddot winner 2023

produktbeschreibung

LTwo® - Light Tube with Optics. Hochpräzise 60° Optik mit rechteckiger Entblendung und max. 4.223 Lumen, basierend auf dem modularen, miniaturisierten LTWO® Lichtquellen-/Leuchtensystem mit 13 hochwertigen Präzisionsoptiken und umfangreichem Zubehör, für alle Beleuchtungsanwendungen. Mit neu entwickelter, multifunktionaler Lampen-/ Leuchtenfassung für einfache, werkzeuglose, magnetische Installation und Winkeleinstellung in +/-20°, sowie Verriegelung. Kodierter Sockel, für sicheren Betrieb von Lampen-/Leuchten mit unterschiedlichen Betriebsströmen in Constant Voltage oder Constant Current. Sehr umweltfreundlich durch minimalen Materialeinsatz (180g/m), Austauschbarkeit, Recyclingfähigkeit und die hohe Effizienz (bis zu 180 lm/W).

- LTWO® 60° - wide flood - Constant Current @600mA - 25 W/m mit 16,4 mm Durchmesser
- Erhältlich in schwarz (RAL9005) und weiß (RAL9016)
- Längen: 142 mm, 282 mm, 562 mm, 842 mm, 1122 mm und 1402 mm
- Wattagen: 3,4 W; 6,8 W; 13,7 W; 20,5 W; 27,3 W; 34,1 W
- Lumen @5000K: 422 lm, 845 lm, 1.689 lm, 2.534 lm, 3.378 lm, 4.223 lm
- Optische Effizienz: 75 % (BB), 82 % (WW)
- UGR von 15,0 / 16,6 (BB), 16,2 / 17,2 (WW) @1.000 lm
- Ideal zur Grundbeleuchtung, z. B. im Bereich der Bürobeleuchtung
- DIN EN 12464-1 konform
- Optimal geeignet für Gebäude und Materialintegration aller Art
- Dimmbar (linear)
- Benötigt magnetische Lampenfassung als notwendiges Zubehör

Achtung: alle nachfolgenden optischen und elektronischen Daten haben eine Toleranz von +/- 10%.
Attention: all following optical and electronic data have a tolerance of +/- 10%.

product description

LTWO® - Light Tube with Optics. High-precision 60° optics with rectangular glare control and max. 4,223 lumen, based on the modular, miniaturised LTWO® light source/luminaire system with 13 high-quality precision optics and extensive accessories, for all lighting applications. With newly developed, multifunctional lamp/luminaire holder for easy, tool-free, magnetic installation and angle adjustment in +/-20°, as well as locking. Coded socket, for safe operation of lamp luminaires with different operating currents in Constant Voltage or Constant Current. Very environmentally friendly due to minimal use of material (180g/m), interchangeability, recyclability and high efficiency (up to 180 lm/W).

- LTWO® 60° - wide flood - Constant Current @600mA - 25 W/m with 16.4 mm diameter
- Available in black (RAL9005) and white (RAL9016)
- Lengths: 142 mm, 282 mm, 562 mm, 842 mm, 1122 mm and 1402 mm
- Watts: 3.4 W; 6.8 W; 13.7 W; 20.5 W; 27.3 W; 34.1 W
- Lumen @5000K: 422 lm, 845 lm, 1,689 lm, 2,534 lm, 3,378 lm, 4,223 lm
- Optical efficiency: 75 % (BB), 82 % (WW)
- UGR of 15.0 / 16.6 (BB), 16.2 / 17.2 (WW) @1,000 lm
- Ideal for ambient lighting, e.g. in the office lighting sector
- DIN EN 12464-1 compliant
- Optimally suited for buildings and material integration of all kinds
- Dimmable (linear)
- Requires magnetic luminaire holder as necessary accessory



Siehe Legende auf der letzten Seite / legend on the last page

produkteigenschaften / product features

Maße / Dimensions

16,4 mm Durchmesser / diameter

Länge / Length (mm)

142 mm, 282 mm, 562 mm, 842 mm, 1122 mm, 1402 mm
3,4W; 6,8W; 13,7W; 20,5W; 27,3W; 34,1W
422 lm, 845 lm, 1689 lm, 2534 lm, 3378 lm, 4223 lm

Qty. LED

16 per 280 mm

LED Pitch

17,5 mm

CCT / CRI

2700K, 3000K, 3500K, 4000K (>90), 5000K (>80)

Binning

3 SDCM

Lebensdauer / Lifetime

60000h L80B10

Schutzklasse / Protection

class IP20 (nur für Innenräume! / indoor use only!)

Risikogruppe / Risk group

RG1

Betriebsart / Operating Mode

Constant Current (CC)

Betriebsspannung / Operating Voltage

</=600mA

Gehäusetemp / Housing temperatur (Tc)

min. -20° / max. +70°

Umgebungstemperatur / Ambient temperature (Ta)

min. -20° / max. +35°

Lagertemperatur / Storage temperatur (Ts)

min. -20° / max. 85°

bestellcode / order code

Bitte tragen Sie hier den Code ein / Please enter code here:

Product	OP	NP	Optic	L	PC	C	LH	IP
APL LTwo®T5	CC	25	60				MAG	IP20
APL LTwo®T5	CC	25	60	140	927	BB	MAG	IP20
				280	930	WW		
				560	935			
				840	940			
				1120	850			
				1400				

beispiel bestellcode / example order code

APL LTwo®T5 CC 25 60 280 927 BB MAG IP20

OP	Betriebssystem / operating system	CC	Konstantstrom / Constant Current
NP	Normleistung pro m / nominal power per m	BB	schwarzes Profil – schwarze Entblendung / black profile – black antiglare
Optic	Optik / optics	WW	weißes Profil – weiße Entblendung / white profile – white antiglare
L	Länge / length	MAG	magnetische Lampenfassung / magnetic luminaire holder
PC	Photometrischer Code* / photometric code*		
C	Gehäusefarbe / housing colour		
LH	Lampenfassung / luminaire holder		
IP	Schutzart / protection class		

*Photometrischer Code Beispiel / photometric code example:
927 (9 = CRI >90 | 27 = 2700K)

LTwo® – 60° – wide flood constant current – @600mA – 25 W/m

White Black

CRI / CCT	Kelvin	140 mm 3,4 W	280 mm 6,8 W	560 mm 13,7 W	840 mm 20,5 W	1120 mm 27,3 W	1400 mm 34,1 W	Effizienz lm/W
927	2700K	327	654	1308	1962	2616	3270	95,8
		299	598	1196	1794	2393	2991	87,6
930	3000K	352	703	1406	2109	2813	3516	103,0
		322	643	1286	1929	2573	3216	94,2
935	3500K	336	672	1345	2017	2690	3362	98,5
		308	615	1230	1845	2460	3075	90,1
940	4000K	352	703	1406	2109	2813	3516	103,0
		322	643	1286	1929	2573	3216	94,2
850	5000K	422	845	1689	2534	3378	4223	123,8
		386	773	1545	2318	3090	3863	113,2
Typ. Vf (V) – 600 mA		6,22	11,99	23,54	35,21	46,78	46,30	

lichtverteilung / light distribution

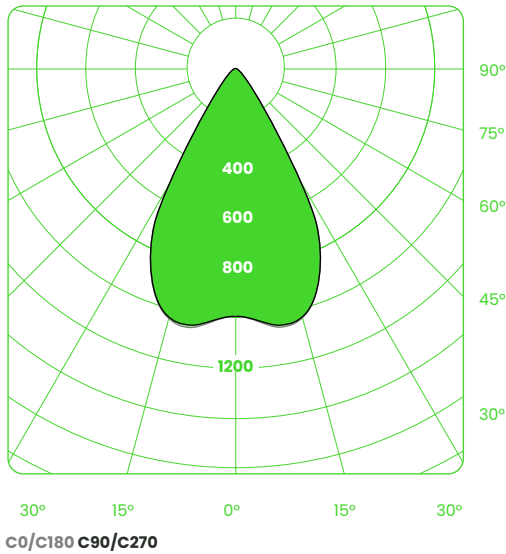

LTwo® schwarz / black – 60°, 560mm

notwendiges zubehör / necessary accessories



- Weiß / White
MS-T5-C2-7A (W-9016)
10453
- Schwarz / Black
MS-T5-C2-7A (B-9005)
10454

LTwo® magnetische Lampenfassung PIT-Block 3-polig – Constant Current
zur Aufnahme 3-poliger Kabel für den elektrischen Anschluss an externe PSU

LTwo® magnetic luminaire holder PIT-block 3-pole – Constant Current
to accommodate 3-pole cables for electrical connection to external PSU



- Weiß / White
MS-T5-C2-1A (W-9016)
10455
- Schwarz / Black
MS-T5-C2-1A (B-9005)
10456

LTwo® magnetische Lampenfassung JST 3-polig – Constant Current
zur Aufnahme des 3-poligen Kabelsatzes mit JST-Stecker und offenen Kabelenden (CA-CC-324-30E-B-1 (100cm)) für den elektrischen Anschluss an externe PSU

LTwo® magnetic luminaire holder JST 3-pole – Constant Current
to accommodate the 3-pole cable set with JST-connector and open cable ends (CA-CC-324-30E-B-1 (100cm)) for electrical connection to external PSU



- Schwarz / Black
CA-CC-324-30E-B-1 (100 cm)
10458

3-poliger Kabelsatz mit JST-Stecker für LTwo® magnetische Lampenfassung Constant Current – 1m
zur einfachen Verbindung der LTwo® magnetischen Lampenfassung mit externer PSU

3-pole cable set with JST-connector for LTwo® magnetic luminaire holder Constant Current – 1m
for easy connection of the LTwo® magnetic luminaire holder with external PSU

montagezubehör / mounting accessories



- Weiß / White
MH-T5-EE-1D (W-9016)
10460
- Schwarz / Black
MH-T5-EE-1D (B-9005)
10459

Rechteckige Montagehalterung
für LTwo® magnetische Lampenfassung
zur vorderseitigen Montage

Rectangular mounting bracket
for LTwo® magnetic luminaire holder
for front mounting



- Weiß / White
MH-T5-ER-1D (W-9016)
10462
- Schwarz / Black
MH-T5-ER-1D (B-9005)
10461

Runde Montagehalterung
für LTwo® magnetische Lampenfassung
zur vorderseitigen Montage

Round mounting bracket
for LTwo® magnetic luminaire holder
for front mounting

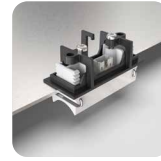

- Schwarz / Black
MH-T5-SR-1C (B-9005)
10463

Rückseitige Montagehalterung
zum Verschrauben
für LTwo® magnetische Lampenfassung

Rear mounting bracket
for screwing
for LTwo® magnetic luminaire holder



- Schwarz / Black
MH-T5-RA-1C (B-9005)
10493

Rückseitige Montagehalterung
zum Verrasten
für LTwo® magnetische Lampenfassung

Rear mounting bracket
to snap in
for LTwo® magnetic luminaire holder



- Weiß / White
MH-T5-UD-2F (W-9016)
10466
- Schwarz / Black
MH-T5-UD-2F (B-9005)
10465

Unterputzdosen-Montagehalterung
für LTwo® magnetische Lampenfassung

Flush-box mounting bracket
for LTwo® magnetic luminaire holder



- Weiß / White
MH-T5-HI-1D (W-9016)
10468
- Schwarz / Black
MH-T5-HI-1D (B-9005)
10467

Gehäuse mit Innengewinde
für LTwo® magnetische Lampenfassung
(Zubehör zur Abpendelung und für Stromschienen)

Housing with internal thread
for LTwo® magnetic luminaire holder
(accessories for suspension and track)



- Weiß / White
MH-T5-W1-1 (W-9016)
10471
- Schwarz / Black
MH-T5-W1-1 (B-9005)
10469

90° Winkel-Adapter
für LTwo® magnetische Lampenfassung

90° angle adapter
for LTwo® magnetic luminaire holder

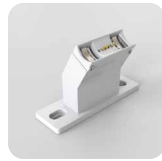

- Weiß / White
MH-T5-W2-1A (W-9016)
10472
- Schwarz / Black
MH-T5-W2-1A (B-9005)
10470

30° Winkel-Adapter (Museumswinkel)
für LTwo® magnetische Lampenfassung



30° angle adapter (museum angle)
for LTwo® magnetic luminaire holder

icon legende / icon legend



Lichtverteilung Light distribution

-  10° HB Narrow spot
Narrow spot
-  13° Spot
Spot
-  25° Narrow flood
Narrow flood
-  40° Flood
Flood
-  60° Wide flood
Wide flood
-  90° Extra wide flood
Extra wide flood
-  BWN Batwing narrow
Batwing narrow
-  BWW Batwing wide
Batwing wide
-  WW Wallwash
Wallwash
-  CL Klare Abdeckung
Clear cover
-  DF Diffuse Abdeckung
Diffuse cover
-  OP Opale Abdeckung
Opal cover
-  OVAL Ovale Abdeckung
Oval cover

Abstrahlrichtung Beam direction

-  Direkt
Direct
-  Indirekt
Indirect
-  Direkt / Indirekt
Direct / Indirect











Betriebsart Operation modes

-  CV Konstantspannung
Constant voltage
-  48V 48 Volt
48 Volt
-  12W 12 Watt
12 Watt
-  20W 20 Watt
20 Watt
-  CC Konstantstrom
Constant current
-  300 mA 300 mA
300 mA
-  600 mA 600 mA
600 mA







Schutzklassen Protection class

-  IP20 Schutzklasse
Protection class
-  IP54 Schutzklasse
Protection class
-  IP67 Schutzklasse
Protection class
-  Innenbereich
Indoor
-  Schutzklasse 1
Protection class 1
-  Schutzklasse 2
Protection class 2
-  Schutzklasse 3
Protection class 3
-  SELV Zusätzliche Sicherheit /
Niederspannung
Extra safety /
low voltage

Lichtqualität light quality

-  2700 K Farbtemperatur
Color temperature
-  3000 K Farbtemperatur
Color temperature
-  3500 K Farbtemperatur
Color temperature
-  4000 K Farbtemperatur
Color temperature
-  5000 K Farbtemperatur
Color temperature
-  CRI >80 Farbwiedergabeindex
Color rendering index
-  CRI >90 Farbwiedergabeindex
Color rendering index
-  60 kh Lebensdauer
Lifetime
-  L80 B10 Lebensdauer
Lifetime
-  LM 80 LM80 konform
LM80 compliant
-  UGR <16 Blendungsbewertung
Unified glare rating

Montageart Mounting type

-  Anbau Decke
Ceiling
-  Anbau Boden
Floor
-  Einbau Decke
Recessed ceiling
-  Einbau Boden
Recessed floor
-  Pendel
Pendant
-  Anbau Wand
Wall

icon legende / icon legend

Steuerung Control

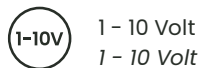

1 – 10 Volt
1 – 10 Volt



DALI
DALI

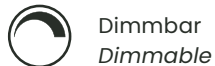

Dimmbar
Dimmable

Zertifikate Certificates

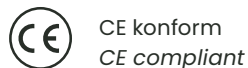

CE konform
CE compliant

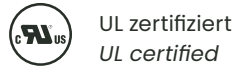

UL zertifiziert
UL certified

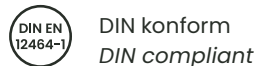

DIN konform
DIN compliant

Sonstiges Others

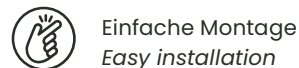

Einfache Montage
Easy installation



Weiss
White



Schwarz
Black

Fassung luminaire holder



Magnetisch
Magnetic



Schwenkbar
tiltable



Sicherheitsbügel
Safety bracket