

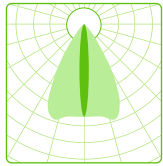

LTwo® – BWN – batwing narrow (linear) constant voltage 48V – 12 watt/m



Ø 16,4 mm



Gesamthöhe
total height
21,6 mm

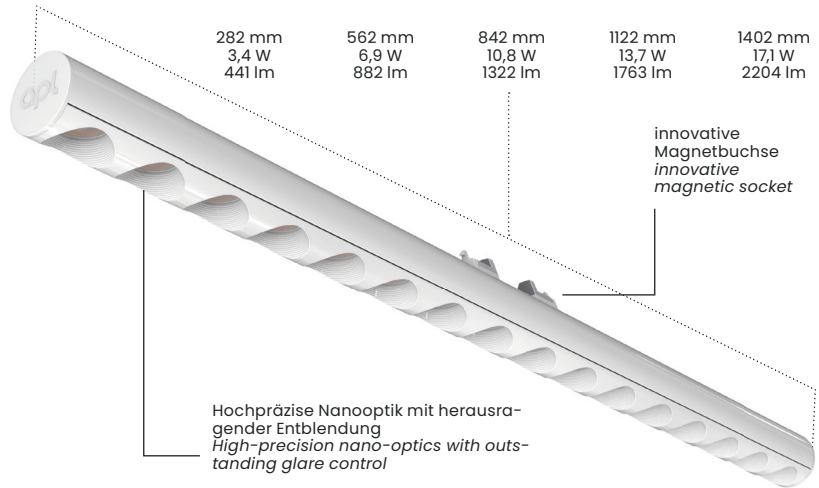

282 mm
3,4 W
441 lm

562 mm
6,9 W
882 lm

842 mm
10,8 W
1322 lm

1122 mm
13,7 W
1763 lm

1402 mm
17,1 W
2204 lm

innovative
Magnetbuchse
innovative
magnetic socket

Hochpräzise Nanooptik mit heraus-
gehender Entblendung
High-precision nano-optics with outs-
tanding glare control



reddot winner 2023

produktbeschreibung

LTwo® – Light Tube with Optics. Hochpräzise Batwing narrow (BWN) Optik mit max. 2.204 Lumen, basierend auf dem modularen, miniaturisierten LTwo® Lichtquellen-/Leuchtensystem mit 13 hochwertigen Präzisionsoptiken und umfangreichem Zubehör, für alle Beleuchtungsanwendungen. Mit neu entwickelter, multifunktionaler Lampen-/ Leuchtenfassung für einfache, werkzeuglose, magnetische Installation und Winkeleinstellung in +/-20°, sowie Verriegelung. Kodierter Sockel, für sicheren Betrieb von Lampen-Leuchten mit unterschiedlichen Betriebsströmen in Constant Voltage oder Constant Current. Sehr umweltfreundlich durch minimalen Materialeinsatz (180g/m), Austauschbarkeit, Recyclingfähigkeit und die hohe Effizienz (bis zu 180 lm/W).

- LTwo® BWN – Batwing narrow (linear) – Constant Voltage 48V – 12W/m mit 16,4 mm Durchmesser
- Erhältlich in schwarz (RAL9005) und weiß (RAL9016)
- Längen: 282 mm, 562 mm, 842 mm, 1122 mm, 1402 mm
- Wattagen: 3,4 W; 6,9 W; 10,8 W; 13,7 W; 17,1 W
- Lumen @5000K: 441 lm, 882 lm, 1.322 lm, 1.763 lm, 2.204 lm
- Optische Effizienz: 71 % (BB), 82 % (WW)
- UGR von 19,7 / 6,3 (BB), 20,5 / 15,9 (WW) @750lm
- Ideal für asymmetrische Beleuchtungsaufgaben, z.B. im Bereich der Flur- und Wegebeleuchtung
- Optimal geeignet für Gebäude und Materialintegration aller Art
- Dimmbar (PWM)
- Benötigt magnetische Lampenfassung als notwendiges Zubehör

product description

LTwo® – Light Tube with Optics. High-precision Batwing narrow (BWN) optics with max. 2,204 lumen, based on the modular, miniaturised LTwo® light source/luminaire system with 13 high-quality precision optics and extensive accessories, for all lighting applications. With newly developed, multifunctional lamp/luminaire holder for easy, tool-free, magnetic installation and angle adjustment in +/-20°, as well as locking. Coded socket, for safe operation of lamp luminaires with different operating currents in Constant Voltage or Constant Current. Very environmentally friendly due to minimal use of material (180g/m), interchangeability, recyclability and high efficiency (up to 180 lm/W).

- LTwo® BWN – Batwing narrow (linear) – Constant Voltage 48V – 12W/m with 16.4 mm diameter
- Available in black (RAL9005) and white (RAL9016)
- Lengths: 282 mm, 562 mm, 842 mm, 1122 mm, 1402 mm
- Watts: 3,4 W; 6,9 W; 10,8 W; 13,7 W; 17,1 W
- Lumen @5000K: 441 lm, 882 lm, 1,322 lm, 1,763 lm, 2,204 lm
- Optical efficiency: 71 % (BB), 82 % (WW)
- UGR of 19.7 / 6.3 (BB), 20.5 / 15.9 (WW) @750lm
- Ideal for asymmetrical lighting tasks, e.g. in the area of corridor and pathway lighting
- Optimally suited for buildings and material integration of all kinds
- Dimmable (PWM)
- Requires magnetic luminaire holder as necessary accessory

Achtung: alle nachfolgenden optischen und elektronischen Daten haben eine Toleranz von +/- 10%.

Attention: all following optical and electronic data have a tolerance of +/- 10%.

apl

All Purpose Lighting
Lahnstraße 30
45478 Mülheim a. d. Ruhr

+49 / (0)208 20777400
info@apl.ag
apl.ag

Architectural FX

Unit 16, The Business
Center, Molly Millars Lane,
Wokingham, RG41 2QY

+44(0)1344291536
sales@architecturalfx.co.uk
www.architecturalfx.co.uk

apl the ideal
light



Siehe Legende auf der letzten Seite / legend on the last page

produkteigenschaften / product features

Maße / Dimensions

16,4 mm Durchmesser / diameter

Länge / Length (mm)

282 mm, 562 mm, 842 mm, 1122 mm, 1402 mm
3,4W; 6,9W; 10,8W; 13,7W; 17,1W
441 lm, 882 lm, 1322 lm, 1763 lm, 2204 lm

Qty. LED

16 per 280 mm

LED Pitch

17,5 mm

CCT / CRI

2700K, 3000K, 3500K, 4000K (>90) 5000K (>80)

Binning

3 SDCM

Lebensdauer / Lifetime

60000h L80B10

Schutzklasse / Protection

class IP20 (nur für Innenräume! / indoor use only!)

Risikogruppe / Risk group

RG1

Betriebsart / Operating Mode

Constant Voltage (CV)

Betriebsspannung / Operating Voltage

48 V DC -2,0 / +1,75

Gehäusetemp / Housing temperatur (Tc)

min. -20° / max. +65°

Umgebungstemperatur / Ambient temperature (Ta)

min. -20° / max. +45°

Lagertemperatur / Storage temperatur (Ts)

min. -20° / max. 85°

bestellcode / order code

Bitte tragen Sie hier den Code ein / Please enter code here:

Product	OP	NP	Optic	L	PC	C	LH	IP
APL LTwo®T5	CV	12	BWN				MAG	IP20
APL LTwo®T5	CV	12	BWN	280	927	BB	MAG	IP20
				560	930	WW		
				840	935			
				1120	940			
				1400	850			

beispiel bestellcode / example order code

APL LTwo®T5 CV 12 BWN 280 927 BB MAG IP20

OP	Betriebssystem / operating system	CV	Konstantspannung / Constant Voltage
NP	Normleistung pro m / nominal power per m	BB	schwarzes Profil – schwarze Entblendung / black profile – black antiglare
Optic	Optik / optics	WW	weißes Profil – weiße Entblendung / white profile – white antiglare
L	Länge / length	MAG	magnetische Lampenfassung / magnetic luminaire holder
PC	Photometrischer Code* / photometric code*		
C	Gehäusefarbe / housing colour		
LH	Lampenfassung / luminaire holder		
IP	Schutzart / protection class		

*Photometrischer Code Beispiel / photometric code example:
927 (9 = CRI >90 | 27 = 2700K)

LTwo® – BWN – batwing narrow constant voltage 48V – 12 W/m

White Black

CRI/CCT	Kelvin	280 mm	560 mm	840 mm	1120 mm	1400 mm	Lumen/Watt
		3,4 W	6,9 W	10,8 W	13,7 W	17,1 W	
927	2700K	340	681	1021	1361	1702	99,4
		295	589	884	1179	1473	86,0
930	3000K	369	738	1107	1476	1845	107,7
		320	639	959	1278	1598	93,3
935	3500K	351	701	1052	1402	1753	102,4
		304	607	911	1214	1518	88,6
940	4000K	369	738	1107	1476	1845	107,7
		320	639	959	1278	1598	93,3
850	5000K	441	882	1322	1763	2204	128,7
		382	763	1145	1527	1908	111,4

lichtverteilung / light distribution

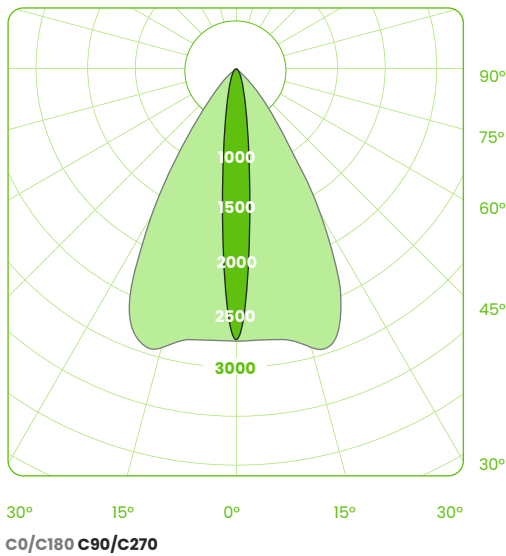

LTwo® schwarz / black - Batwing narrow, 560mm

notwendiges zubehör / necessary accessories



- Weiß / White
MS-T5-C1-7A (W-9016)
10449
- Schwarz / Black
MS-T5-C1-7A (B-9005)
10450



- Weiß / White
MS-T5-C1-1A (W-9016)
10451
- Schwarz / Black
MS-T5-C1-1A (B-9005)
10452

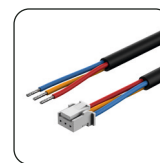

- Schwarz / Black
CA-CV-324-30E-B-1 (100 cm)
10457

LTwo® magnetische Lampenfassung PIT-Block 3-polig – Constant Voltage 48V
zur Aufnahme 3-poliger Kabel für den elektrischen Anschluss an externe PSU

LTwo® magnetic luminaire holder PIT-block 3-pole – Constant Voltage 48V
to accommodate 3-pole cables for electrical connection to external PSU

LTwo® magnetische Lampenfassung JST 3-polig – Constant Voltage 48V
zur Aufnahme des 3-poligen Kabelsatzes mit JST-Stecker und offenen Kabelenden (CA-CV-324-30E-B-1 (100cm)) für den elektrischen Anschluss an externe PSU

LTwo® magnetic luminaire holder JST 3-pole-Constant Voltage 48V
to accommodate the 3-pole cable set with JST-connector and open cable ends (CA-CV-324-30E-B-1 (100cm)) for electrical connection to external PSU

3-poliger Kabelsatz mit JST-Stecker für LTwo® magnetische Lampenfassung Constant Voltage – 1m
zur einfachen Verbindung der LTwo® magnetischen Lampenfassung mit externer PSU

3-pole cable set with JST-connector for LTwo® magnetic luminaire holder Constant Voltage – 1m
for easy connection of the LTwo® magnetic luminaire holder with external PSU

montagezubehör / mounting accessories

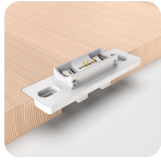

- Weiß / White
MH-T5-EE-1D (W-9016)
10460
- Schwarz / Black
MH-T5-EE-1D (B-9005)
10459

Rechteckige Montagehalterung
für LTwo® magnetische Lampenfassung
zur vorderseitigen Montage

Rectangular mounting bracket
for LTwo® magnetic luminaire holder
for front mounting



- Weiß / White
MH-T5-ER-1D (W-9016)
10462
- Schwarz / Black
MH-T5-ER-1D (B-9005)
10461

Runde Montagehalterung
für LTwo® magnetische Lampenfassung
zur vorderseitigen Montage

Round mounting bracket
for LTwo® magnetic luminaire holder
for front mounting

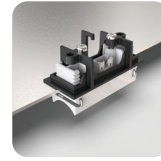

- Schwarz / Black
MH-T5-SR-1C (B-9005)
10463

Rückseitige Montagehalterung
zum Verschrauben
für LTwo® magnetische Lampenfassung

Rear mounting bracket
for screwing
for LTwo® magnetic luminaire holder



- Schwarz / Black
MH-T5-RA-1C (B-9005)
10493

Rückseitige Montagehalterung
zum Verrasten
für LTwo® magnetische Lampenfassung

Rear mounting bracket
to snap in
for LTwo® magnetic luminaire holder



- Weiß / White
MH-T5-UD-2F (W-9016)
10466
- Schwarz / Black
MH-T5-UD-2F (B-9005)
10465

Unterputzdosen-Montagehalterung
für LTwo® magnetische Lampenfassung

Flush-box mounting bracket
for LTwo® magnetic luminaire holder

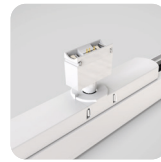

- Weiß / White
MH-T5-HI-1D (W-9016)
10468
- Schwarz / Black
MH-T5-HI-1D (B-9005)
10467

Gehäuse mit Innengewinde
für LTwo® magnetische Lampenfassung
(Zubehör zur Abpendelung und für Stromschienen)

Housing with internal thread
for LTwo® magnetic luminaire holder
(accessories for suspension and track)



- Weiß / White
MH-T5-W1-1 (W-9016)
10471
- Schwarz / Black
MH-T5-W1-1 (B-9005)
10469

90° Winkel-Adapter
für LTwo® magnetische Lampenfassung

90° angle adapter
for LTwo® magnetic luminaire holder

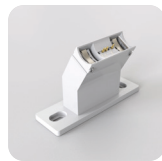

- Weiß / White
MH-T5-W2-1A (W-9016)
10472
- Schwarz / Black
MH-T5-W2-1A (B-9005)
10470

30° Winkel-Adapter (Museumswinkel)
für LTwo® magnetische Lampenfassung



30° angle adapter (museum angle)
for LTwo® magnetic luminaire holder

icon legende / icon legend







Lichtverteilung Light distribution

-  10° HB Narrow spot
Narrow spot
-  13° Spot
Spot
-  25° Narrow flood
Narrow flood
-  40° Flood
Flood
-  60° Wide flood
Wide flood
-  90° Extra wide flood
Extra wide flood
-  BWN Batwing narrow
Batwing narrow
-  BWW Batwing wide
Batwing wide
-  WW Wallwash
Wallwash
-  CL Klare Abdeckung
Clear cover
-  DF Diffuse Abdeckung
Diffuse cover
-  OP Opale Abdeckung
Opal cover
-  OVAL Ovale Abdeckung
Oval cover

Abstrahlrichtung Beam direction

-  Direkt
Direct
-  Indirekt
Indirect
-  Direkt / Indirekt
Direct / Indirect











Betriebsart Operation modes

-  CV Konstantspannung
Constant voltage
-  48V 48 Volt
48 Volt
-  12W 12 Watt
12 Watt
-  20W 20 Watt
20 Watt
-  CC Konstantstrom
Constant current
-  300 mA 300 mA
300 mA
-  600 mA 600 mA
600 mA







Schutzklassen Protection class

-  IP20 Schutzklasse
Protection class
-  IP54 Schutzklasse
Protection class
-  IP67 Schutzklasse
Protection class
-  Innenbereich
Indoor
-  Schutzklasse 1
Protection class 1
-  Schutzklasse 2
Protection class 2
-  Schutzklasse 3
Protection class 3
-  SELV Zusätzliche Sicherheit /
Niederspannung
Extra safety /
low voltage

Lichtqualität light quality

-  2700 K Farbtemperatur
Color temperature
-  3000 K Farbtemperatur
Color temperature
-  3500 K Farbtemperatur
Color temperature
-  4000 K Farbtemperatur
Color temperature
-  5000 K Farbtemperatur
Color temperature
-  CRI >80 Farbwiedergabeindex
Color rendering index
-  CRI >90 Farbwiedergabeindex
Color rendering index
-  60 kh Lebensdauer
Lifetime
-  L80 B10 Lebensdauer
Lifetime
-  LM 80 LM80 konform
LM80 compliant
-  UGR <13 UGR <13

Montageart Mounting type

-  Anbau Decke
Ceiling
-  Anbau Boden
Floor
-  Einbau Decke
Recessed ceiling
-  Einbau Boden
Recessed floor
-  Pendel
Pendant
-  Anbau Wand
Wall

icon legende / icon legend

Steuerung Control

 1 – 10 Volt
1 – 10 Volt

 DALI
DALI

 Dimmbar
Dimmable

Zertifikate Certificates

 CE konform
CE compliant

 UL zertifiziert
UL certified

 DIN EN
12464-1
DIN konform
DIN compliant

Sonstiges Others

 Einfache Montage
Easy installation

 Weiss
White

 Schwarz
Black

Fassung luminaire holder

 Magnetisch
Magnetic

 Schwenkbar
tiltable

 Sicherheitsbügel
Safety bracket