

# APL LTwo® Applications



As a new entrant to the lighting market but with team well versed in creating lighting innovation, APL are aiming to make a difference with their new LTwo® and Lumami® luminaire family.

The APL team have a vision 'To create the ideal lighting standard for all purposes.' And their mission is to offer lighting solutions which are innovative, intuitive and easy to install. Due to their miniaturization and the sustainable and mindful use of resources, both ranges offer superior quality and inspiration in the field of consumer, industrial and architectural applications.



# LTwo<sup>®</sup> MAGNET





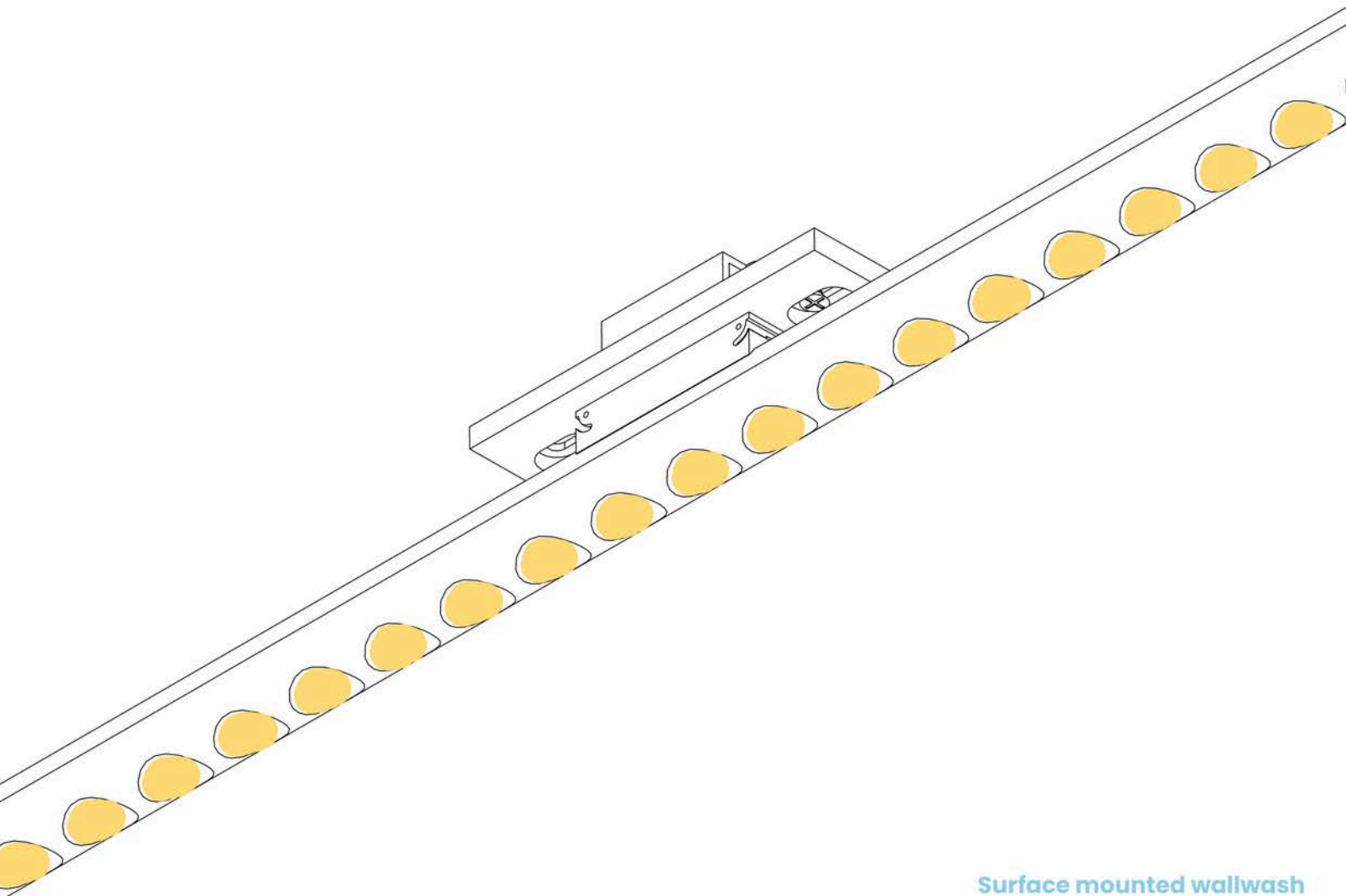
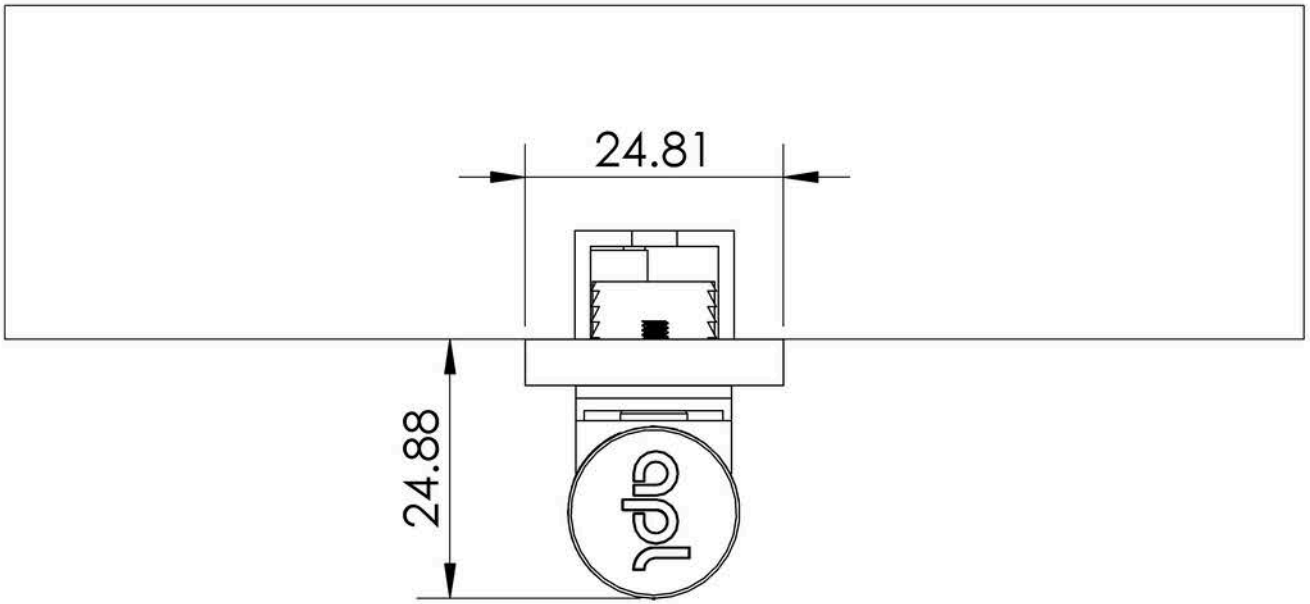

Surface mounted wallwash  
LTwo Magnet, Wallwash  
1120mm



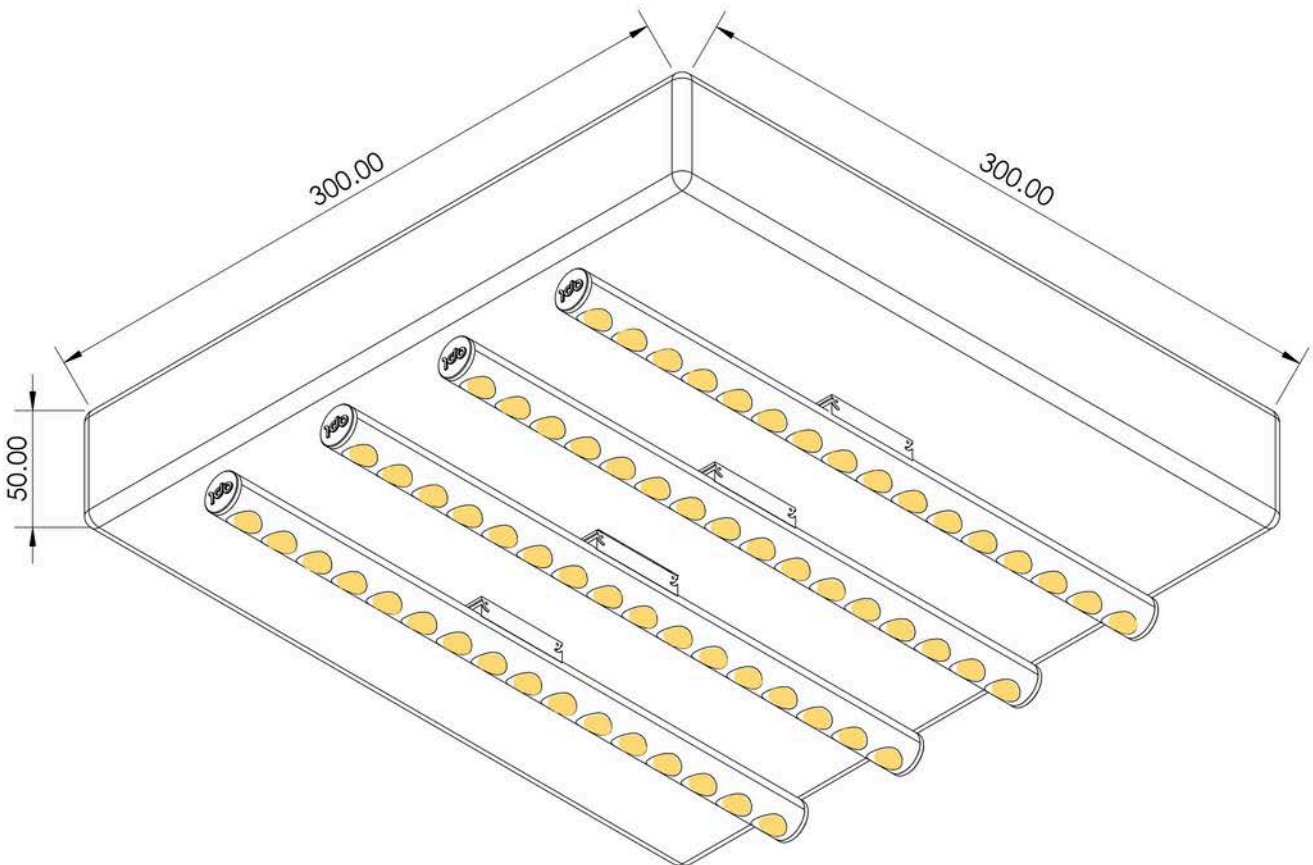
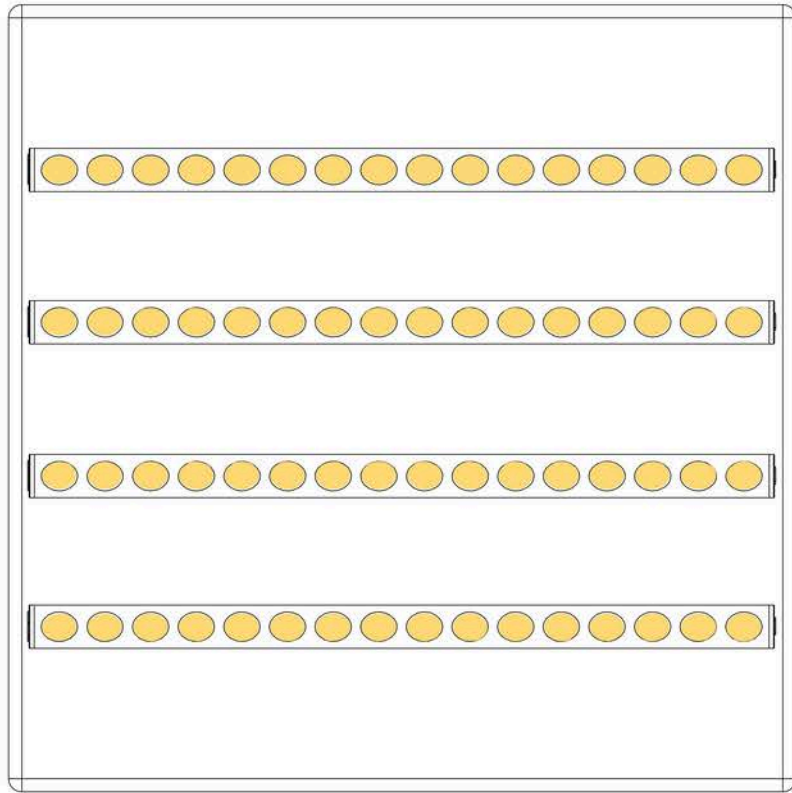



**BUILD  
BACK  
BETTER**  
GOLD  
**WINNER**



**LTwo<sup>®</sup>BATTERY**



The new generation LTWO® battery offers simple easy installation. As it says in the title, it's a battery version of the luminaire with battery contacts to click in place.

This is the ultimate 'lamp luminaire', easy to install and de-install-no new wiring is required. This opens up possibilities to 'future proof' a lighting design' where replacements with alternative optics, colour temperature, or wattage can be used in the future space.

This can adapt a lighting design for new applications or tweak an existing design. This approach is already proving successful with a client who required a higher intensity of light over counter areas, post installation. The existing optic has been replaced by a tighter beam version.

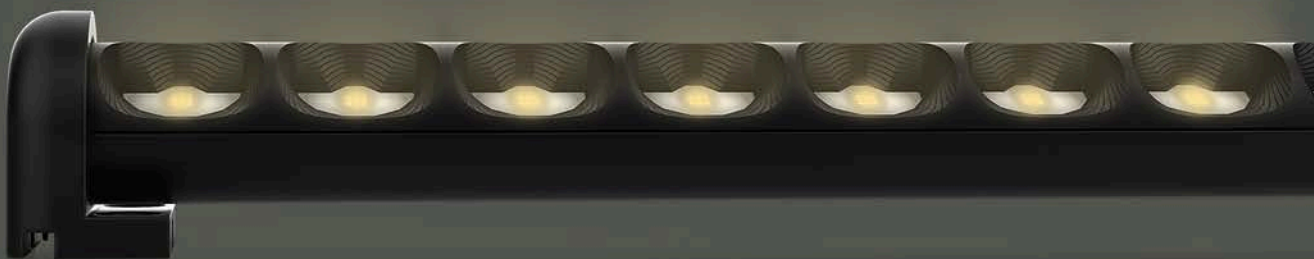

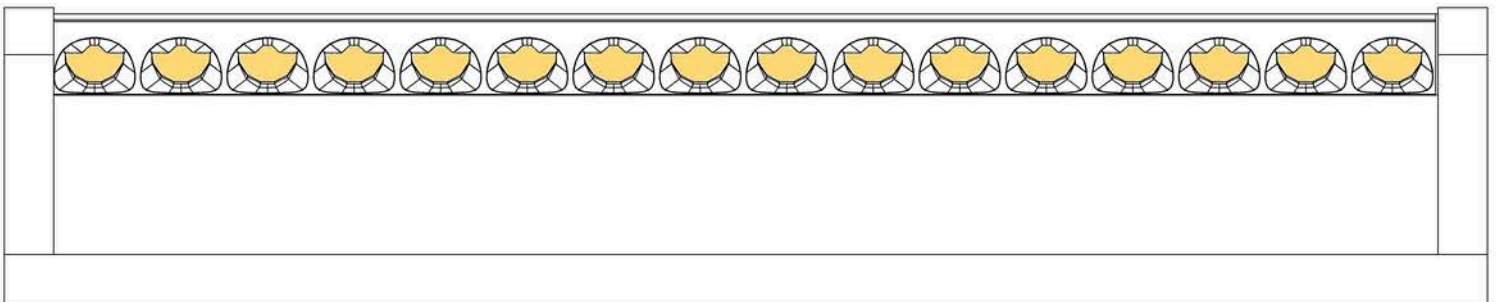
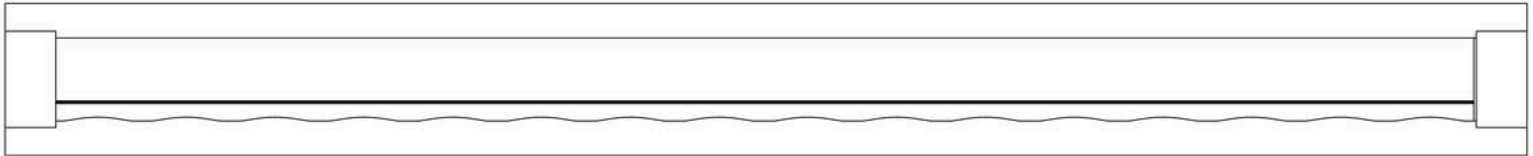
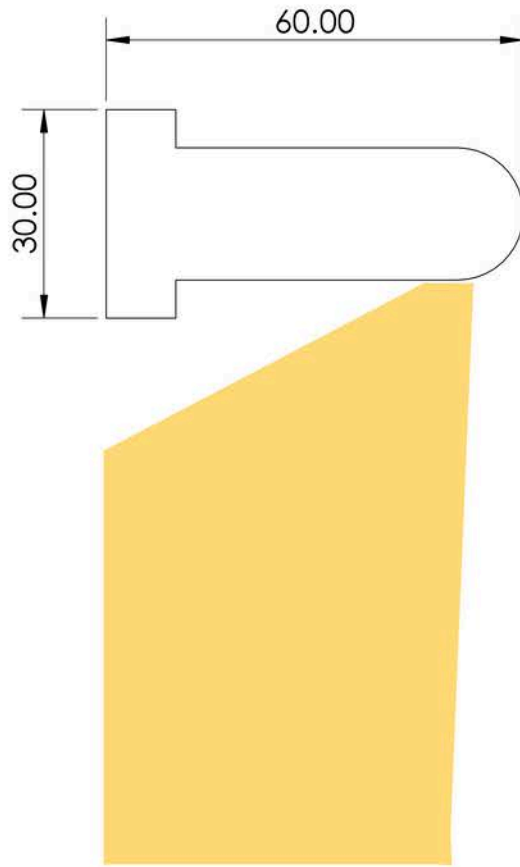

Picture wall light  
LTwo Battery, Wallwash  
280mm



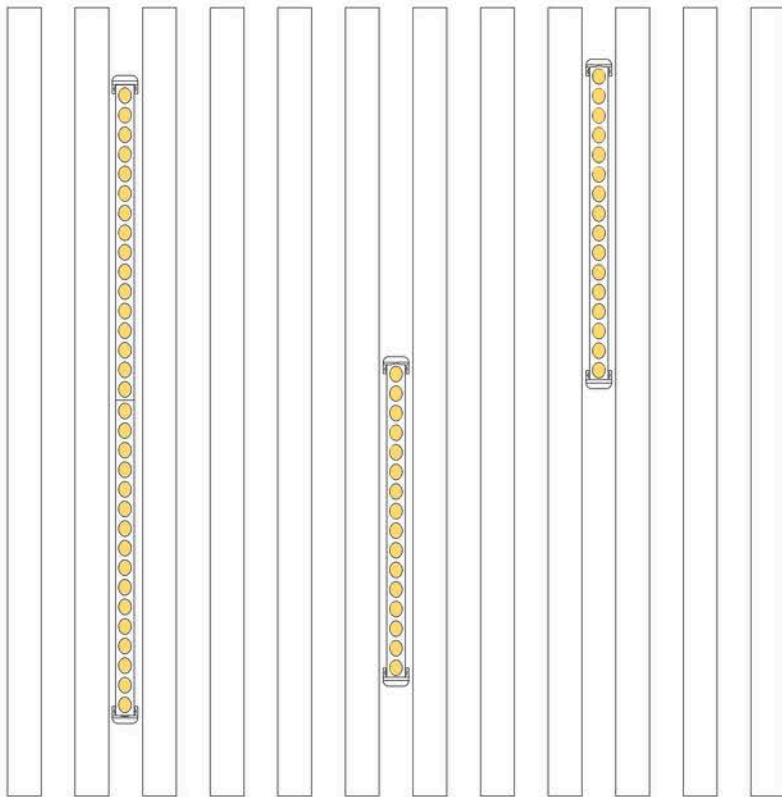
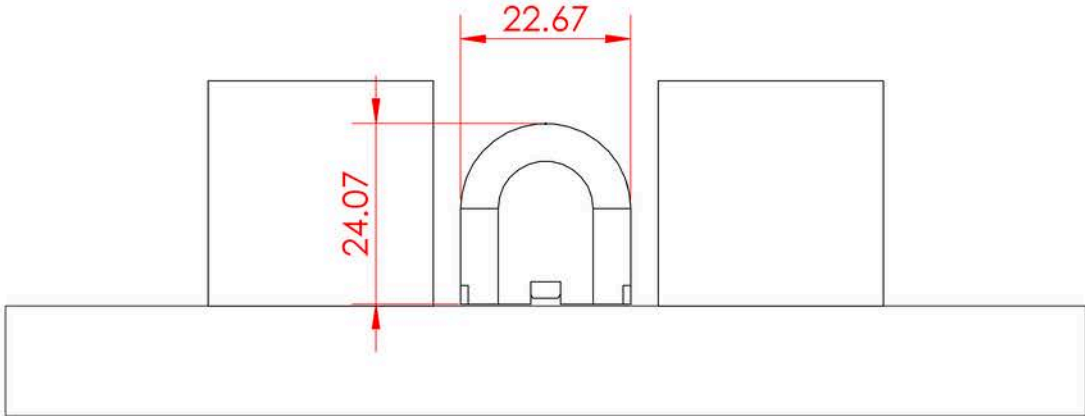

Wooden slats with varying lengths  
LTwo Battery, 25, 60, BWN degrees  
280mm, 580mm



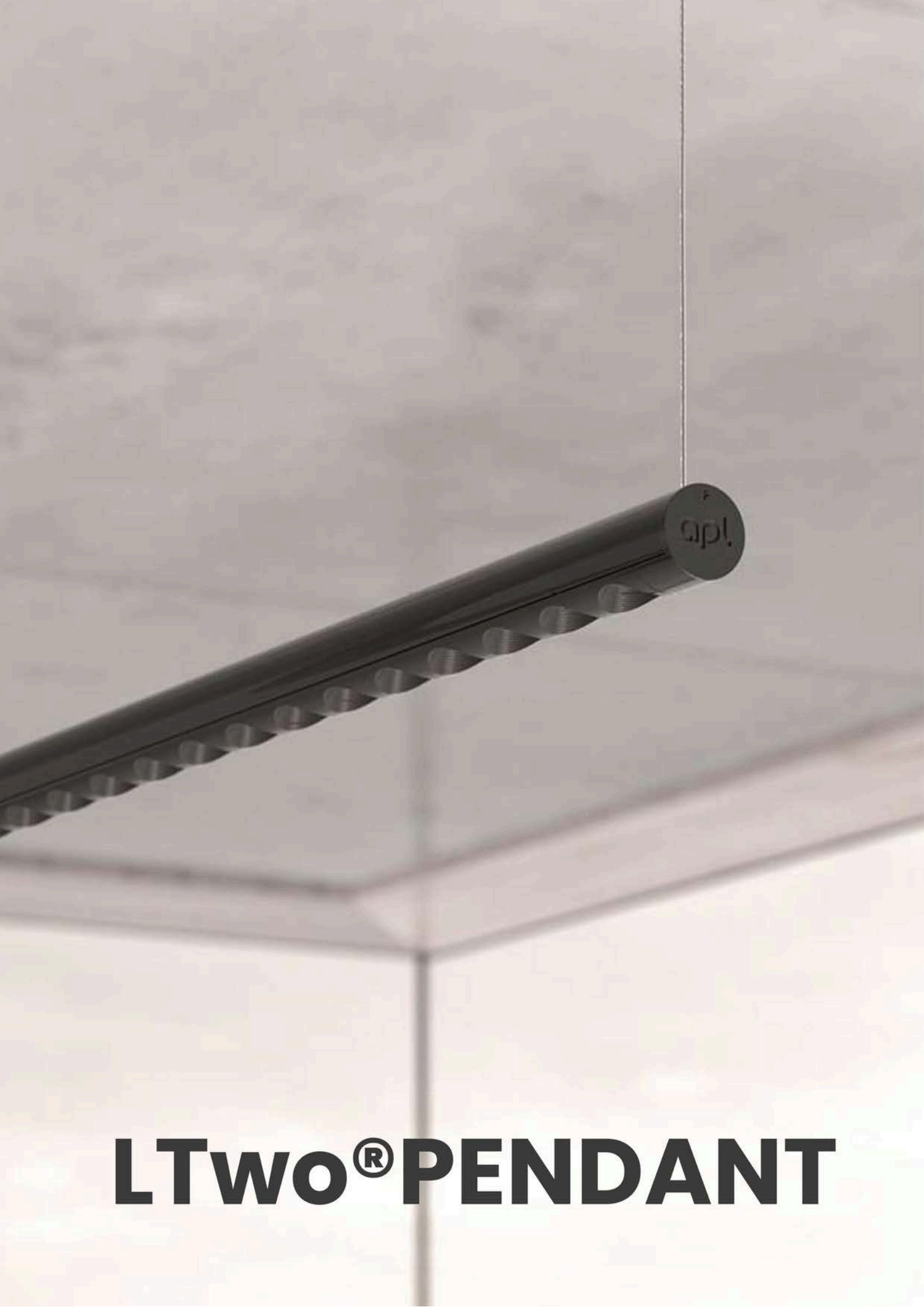

# LTwo<sup>®</sup>PENDANT

Tool-free height adjustment via ceiling mounted holders

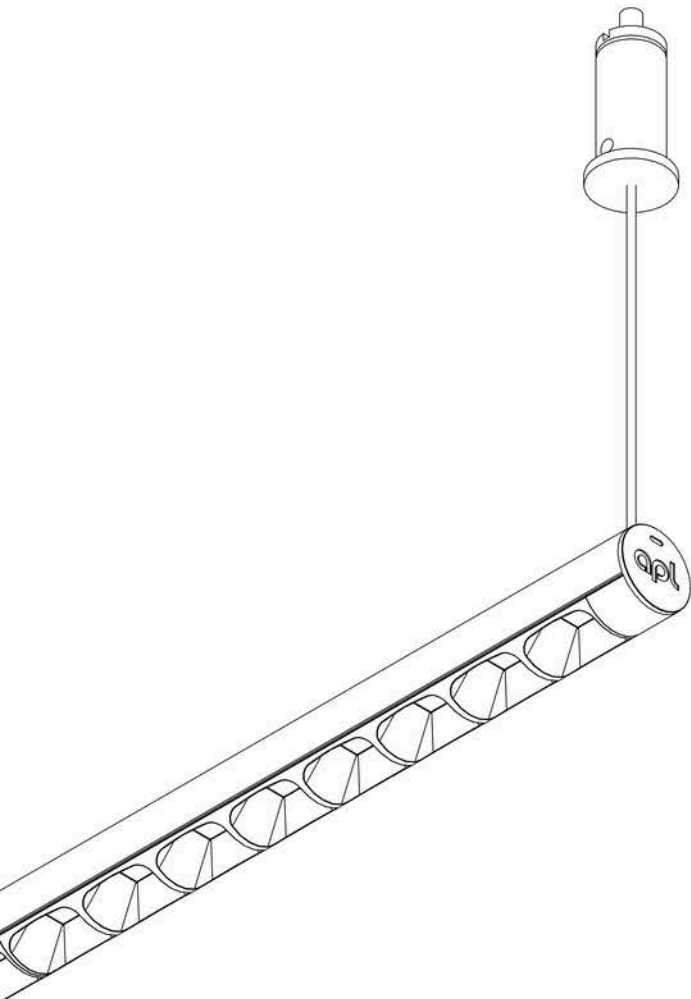
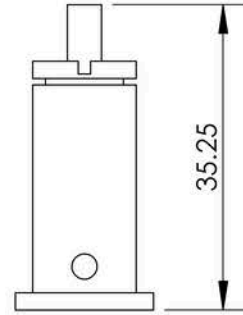
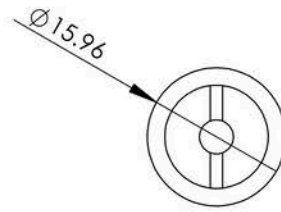
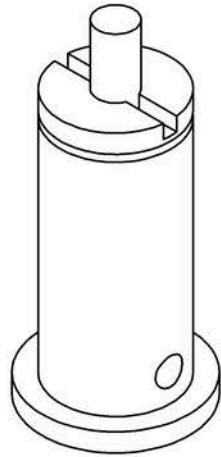



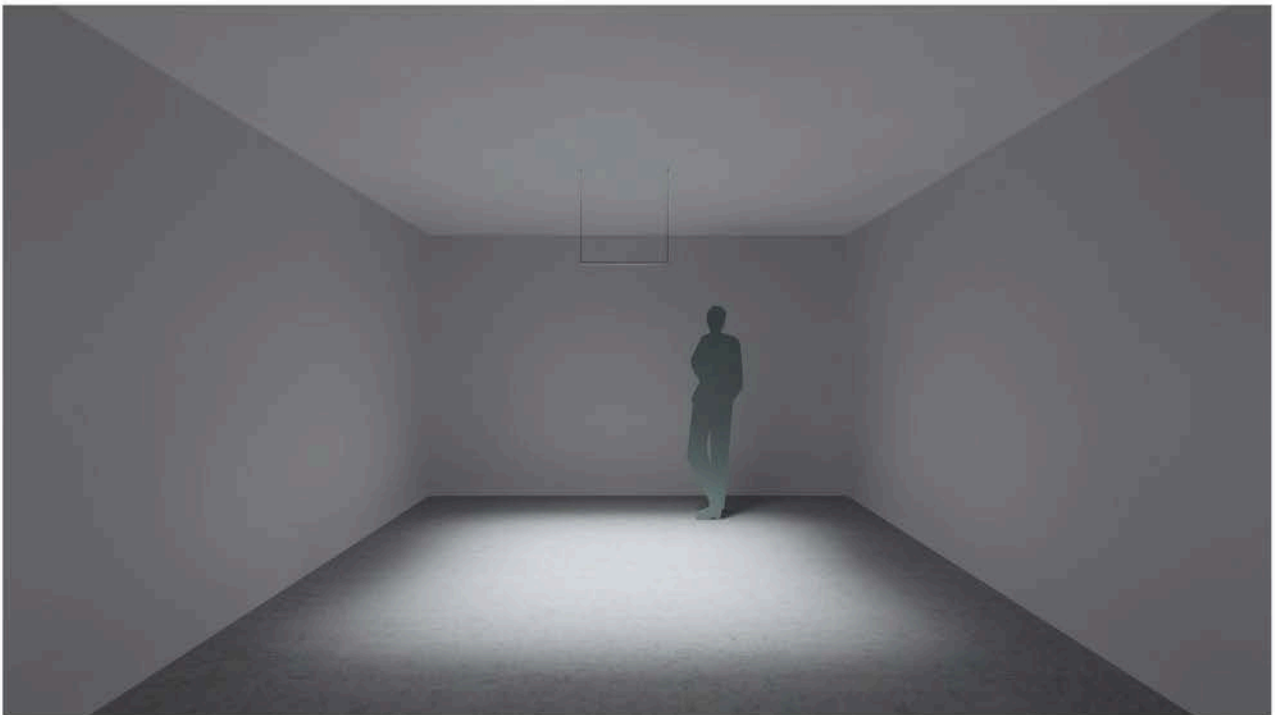
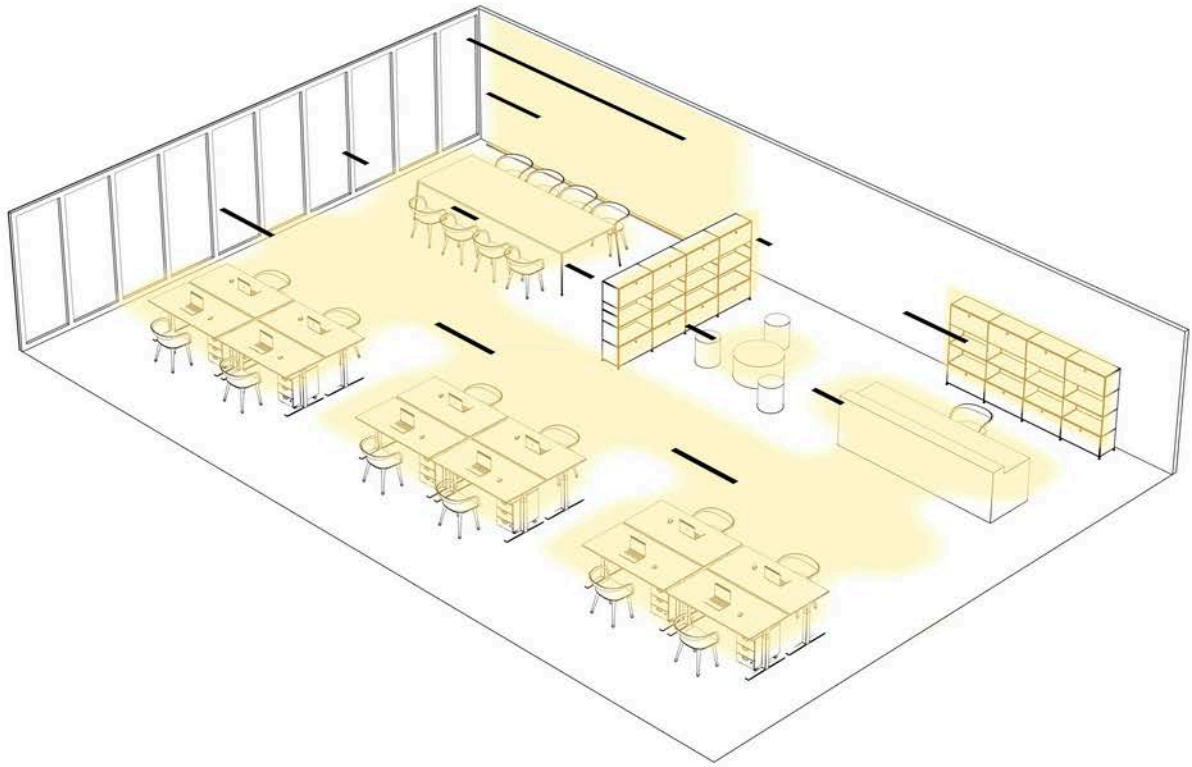

**LTwo Pendant, 60, degrees**  
**1120mm**  
**pendent suspended with cables and ceiling mount**



# Cradle to Cradle

Products designed for disassembly  
and material separation

Precision optics reducing over-illumination  
and operational carbon

Metals, plastics, and electronics are  
easy to disassemble for recycling

Aluminium: 124 g/m, Plastic: 49.5 g/m – all recyclable  
and easy to disassemble.

Only 5,5gr/m of non-recyclable electronics  
(only 3% of product weight).

all non-electrical components recyclable, 87%

## TM66 Certified



# Want to see more?

Scan the QR codes below and head over to our website to see more datasheets, accessories, DWGs and LDT files.



## LTWO Product Datasheets

Scan the QR codes below and head over to our website to see more datasheets, accessories, DWGs and LDT files.



## LTWO Magnet Accessories

Scan the QR codes below and head over to our website to see more datasheets, accessories, DWGs and LDT files.



## APL Product Story

Scan the QR codes below and head over to our website to see more datasheets, accessories, DWGs and LDT files.